

HEAVY-DUTY PIT JACKS

SCORPION PJ25



Turn your under-utilized inspection pit or lube pit into a full service bay with a PJ25 Pit Jack

Ideal for all Heavy-Duty Truck and Bus repair shops.



Perform service on wheels and tires
brakes & suspension
alignment and much more...

25,000 Lb. Cap.
Dual Hydraulic Cylinders
Three Stage Safety Lock
Low Profile Design

STAN DESIGN

866 782 6529 · STANJACKS.COM

HEAVY-DUTY PIT JACKS

SCORPION PJ25



Lock engaged



Lock dis-engaged

All new three stage safety lock
with pneumatic release

Typical Pit

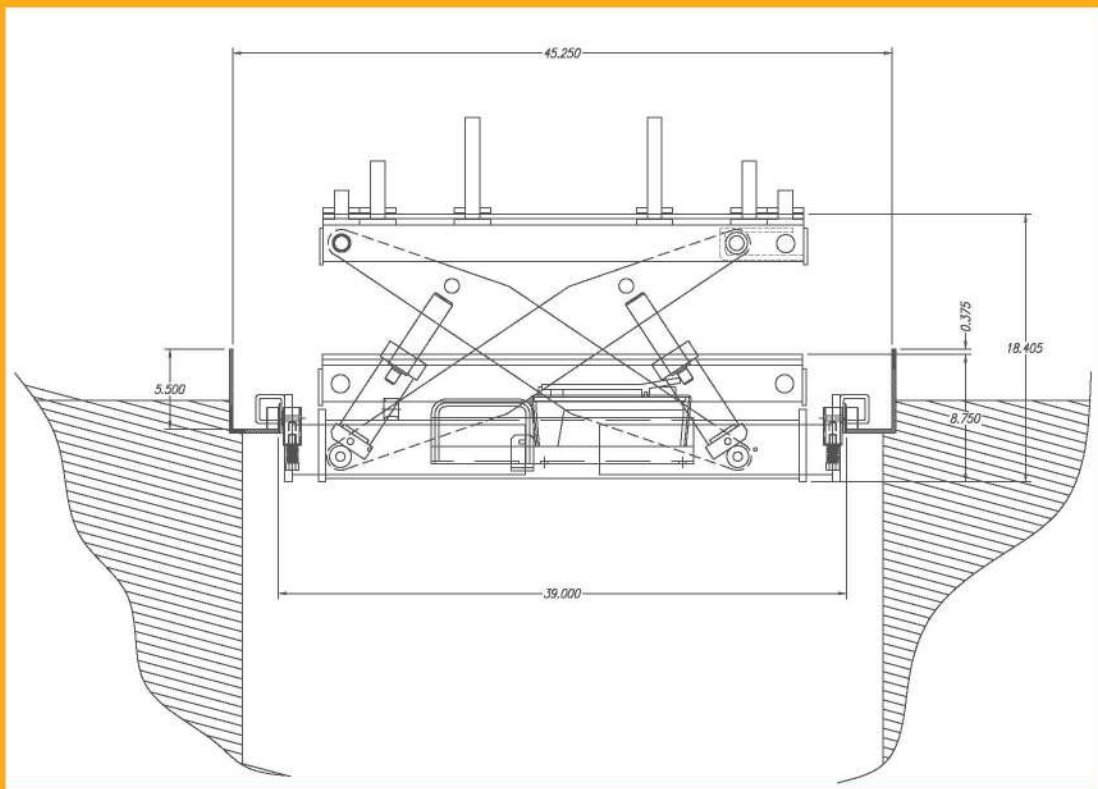

All Scorpion Pit Jacks are custom designed to fit your pit